

INSTALLATION INSTRUCTIONS

MSD Ultra 6AL Ignition Control PN 6423 (Red), PN 64233 (Black)

ONLINE PRODUCT REGISTRATION: Register your MSD product online. Registering your product will help if there is ever a warranty issue with your product and helps the MSD R&D team create new products that you ask for! Go to www.msperformance.com/registration.

Parts Included:

1 - MSD Ultra 6AL	1 - Main Harness
1 - Mag Pick-up Harness, PN 8860	1 - Parts Bag

Note: The Ultra 6AL has not been CARB certified, therefore it is not legal for California use.

Important: When installing the Ultra 6 Series Ignition, timing will be affected, reset to your engine's specifications.

Note: The MSD Ultra 6A uses its own custom app for monitoring and feature editing. It can also interface with the MSD View Software.

For certain applications, the MSD Ultra 6AL can be used as an ignition amplifier with limiter functions and no more than 10 degrees of step retard. See pages 14 thru 21.

OPERATION AND FEATURES

DIGITAL OPERATION

The Ultra 6AL Series continues to use a high speed controller that can make extremely quick compensations to the output voltage, multiple spark series, timing and rpm limits while maintaining precise timing and accurate rev limiting. The circuits and controller of the MSD have been thoroughly filtered to create protection against Electro Magnetic Interference (EMI).

CAPACITIVE DISCHARGE

The Ultra 6AL Series feature a capacitive discharge ignition design. The majority of stock ignition systems are inductive ignitions. In an inductive ignition, the coil must store and step up the voltage to maximum strength in between each firing. At higher rpm, since there is less time to charge the coil to full capacity, the voltage falls short of reaching maximum energy which results in a loss of power or top end miss.

The MSD Ignition features a capacitor which is quickly charged with 540 - 555 volts and stores it until the ignition is triggered. With the CD design, the voltage sent to the coil positive terminal is always at full power even at high rpm.

MULTIPLE SPARKS

The MSD produces full power multiple sparks for each firing of a plug. The number of multiple sparks that occur decreases as rpm increases, however the spark series always lasts for 18° of crankshaft rotation. Above 3,000 rpm there is simply not enough "time" to fire the spark plug more than once, so there is only one powerful spark.

Note: Solid Core spark plug wires cannot be used with an MSD Ignition.

Note: Do not use digital or dial back timing lights.

PROTECTION

The Ultra 6AL Series have a built in reverse polarity protection circuit. This will protect the ignition in the event that the main battery leads are reversed.

WARNING: During installation, disconnect the battery cables. When disconnecting the battery always remove the Negative cable first and install it last.

GENERAL INFORMATION

BATTERY

The Ultra 6AL will operate on any negative ground, 12 volt electrical system with a distributor. The Ultra 6AL can be used with 16 volt batteries and can withstand a momentary 24 volts in the event of jump starts. The ignition will deliver a full voltage with a supply of 7 - 28 volts.

If your application does not use an alternator, allow at least 15 amp/hour for every half hour of operation. The MSD uses about .8 Amps for every 1000 rpm. If the engine is cranked with the same battery or other accessories such as an electric fuel or water pump are used, the amp/hour rating should be higher.

COILS

The Ultra 6AL ignition can be used with most stock coils and aftermarket coils designed to replace the stock coils. The line of MSD Blaster Coils are great for street and mild racing. For extended high rpm operation and maximum output, the Blaster HVC PN 8252 or HVC II PN 8253 are recommended. For more information on recommended coils, check with our Customer Service Department at (866) 464-6553.

TACHOMETERS

The Ultra 6AL features a Gray Tach Output wire that provides a trigger signal for tachometers, shift light or other add-on rpm activated devices. The Tach Output wire produces a 12 volt square wave signal with a 20% duty cycle.

Some vehicles with factory tachometers may require a Tach Adapter to operate with the MSD. For more information on Tachometers and MSD Tach Adapters, see the Tachometer Section on page 5. If your GM vehicle has an in-line filter it may cause the tach to drop to zero on acceleration. If this occurs, bypass the filter.

SPARK PLUGS AND WIRES

Spark plug wires are very important to the operation of your ignition system. A good quality, helically wound wire and proper routing are required to get the best performance from your ignition, such as the MSD 8.5mm Super Conductor Wire. Helically wound wires provide a good path for the spark to follow while keeping Electro Magnetic Interference (EMI) to a minimum. Excessive EMI, such as the amount that solid core wires produce, will interfere with the operation of the MSD. **Solid Core spark plug wires cannot be used with an MSD Ignition.**

Routing: Correct routing of the plug wires is also important to performance. Wires should be routed away from sharp edges and engine heat sources. If there are two wires that are next to each other in the engine's firing order, the wires should be routed away from each other to avoid inducing a spark into the other wire. For example, in a Chevy V8, the firing order is 1-8-4-3-6-5-7-2. The #5 and #7 cylinders are next to each other in the engine and in the firing order. If the voltage from the #5 wire is induced into #7 wire, detonation could occur and cause engine damage.

To add more heat protection to your plug wires, MSD offers Pro-Heat Guard, PN 3411. This is a glass woven and silicone coated protective sleeve that you slide over your plug wires. For extra protection of the spark plug boots, MSD offers Pro Boot Guard, PN 3412.

Spark Plugs: Choosing the correct spark plug design and heat range is important when trying to get the best performance possible. Since there are so many engine combinations and manufacturers, MSD does not recommend which plug or gap is exactly right for your application.

It is recommended to follow the engine builder or manufacturer's specification for spark plugs. With that, you can then experiment with the plug gap by opening them in 0.005" increments, then tested until the best performance is obtained. (See Table 1.)

COMPRESSION	SPARK PLUG GAP
Up to 10.5:1	0.050" - 0.060"
10.5:1 - 13.0:1	0.040" - 0.050"
Above 13.0:1	0.035" - 0.045"

Table 1. Spark Plug Gap

These examples are just starting points to get you going in the right direction. Every application is different and should be tested and tuned.

Welding: If you are welding on your vehicle, to avoid the chance of damage, always disconnect **both** Heavy Power cables of the MSD (You should also disconnect the tach ground wire too).

Distributor Cap and Rotor: It is recommended to install a new distributor cap and rotor when installing the MSD Ignition Control. The cap should be clean inside and out, especially the terminals and rotor tip. On vehicles with smaller caps, it is possible for the air inside the cap to become electrically charged causing crossfire which can result in misfire. This can be prevented by drilling a couple vent holes in the cap. The holes should be placed between the terminals, at rotor height and face away from the intake. If your environment demands it, place a small piece of screen over the hole to act as a filter.

MOUNTING

The MSD Ultra 6AL must be mounted in a sturdy, dry location and not exposed to extreme heat. It is not recommended to mount the unit in an enclosed area such as the glove box. It should be mounted using the included rubber isolators to limit excessive vibration and to provide access to the connector tab for harness removal. The unit should not be immersed or subjected to direct spray from a power washer. When you find a suitable location to mount the unit, make sure the wires of the ignition reach their connections. Hold the Ignition in place and mark the location of the mounting holes. Use a 3/16" bit to drill holes for the mounting hardware.

WIRING

GENERAL WIRING INFORMATION

Wire Length: All of the wires of the MSD Ignition may be shortened as long as quality connectors are used or soldered in place. To lengthen the wires, use one size bigger gauge wire (12 gauge for the power leads and 16 gauge for the other wires) with the proper connections. All connections must be soldered and sealed.

Grounds: A poor ground connection can cause many frustrating problems. When a wire is specified to ground, it should be connected to the battery negative terminal, engine block or chassis. There should always be a ground strap between the engine and the chassis. Always securely connect the ground wire to a clean, paint free metal surface.

Ballast Resistor: If your vehicle has a ballast resistor in-line with the coil wiring, it is recommended to bypass it. See more information under the heading "Ballast Resistor & Engine Run-On"

Routing Wires: The MSD wires should be routed away from direct heat sources such as exhaust manifolds and headers and any sharp edges. The trigger wires should be routed separate from the other wires and spark plug wires. It is best if they are routed along a ground plane such as the block or firewall which creates an electrical shield. The magnetic pickup wires should always be routed separately and should be twisted together to help reduce extraneous interference.

Cylinder Select: The Ultra 6AL is set for operation on 8-cylinder engines by default. A 4 or 6 cylinder engine can be selected with the MSD App under the **Settings** tab. See the Mobile App section for more details.

Pink - Step Retard:

Single stage retard step is activated when 12 volts are applied to the Pink wire. The retard will remain until the 12 volts are removed (OR active when RPM is above the RPM value/setting). Connect to a nitrous solenoid activation wire or switch on the shifter. Retard is adjustable from 0 to 9.9 degrees in 1/10 increments.

Blue - 2-Step:

The Launch Rev Limiter low rpm limit is active when 12V is applied. Rev limit returns to the high limit when 12V is removed.

Lt Blue - Burnout Rev Limit:

Burnout Rev Limit is active when 12V is applied. This overrides other rev limits. It is recommended to have this wire switched from an outside source such as the crew chief before the burnout.

The Ultra 6AL uses a main wiring harness that connects to the ignition through a sealed and locked connection.

POWER LEADS			
The two larger 14 gauge wires are for direct battery voltage to the ignition. The ignition is load protected from reverse battery connections.			
Heavy Red	4&14	Battery Power	This wire connects directly to the battery positive (+) terminal or a positive battery junction such as the starter solenoid. Note: Do not connect to the alternator
Heavy Black	9 & 19	Battery Ground	Connects to a good ground, either at the battery negative (-) terminal or to the engine.
Black	18	Ref GND	Reference ground (Optional)
Red	5	Ignition	Switched 12V (Ignition)
Black	2	Coil (-)	This terminal is the ONLY wire that makes electrical contact with the negative coil terminal.
Orange	3	Coil (+)	This terminal is the ONLY wire that makes electrical contact with the positive coil terminal.
TRIGGER WIRES			
The Points circuit (White), Magnetic Pickup circuit (Green/Violet) and the Hall Effect Input (Red/Black/Green) can be used to trigger the MSD Ignition. Only one should be used at a time.			
White	17	Points	Connect to breaker points, electronic ignition amplifier output or to the Yellow wire of an MSD Timing Accessory. The Magnetic Pickup connector (Violet/Green) and the Hall Effect input are not used.
Violet Green	7 8	Magnetic Pickup	Magnetic Pickup. Plugs directly into an MSD distributor or crank trigger. It will also connect to aftermarket pickups. The Violet wire is positive (+) and the Green wire is negative (-). The White wire and Hall Effect input sensor are not used.
CRANK PICK UP SENSOR			
Red Green Black	5 20 18	Crank Sensor	Hall Effect input - Red supplies +12V to the sensor, black supplies ground and green is the Hall Effect signal input. The White wire and Mag Pickup connector are not used with this configuration.
ACCESSORIES			
Gray	15	Tach	Output tach wire which connects to the tachometer trigger wire or other rpm activated device.
Pink	1	Step Retard	When 12 volts are supplied, the Step Retard is activated.
Lt. Blue	12	Burnout Rev Limit	When 12 volts are applied the Burnout Rev Limit is active. This overrides other rev limits. It is recommended to have this wire switched from an outside source.
Dark Blue	11	Two-Step	When 12 volts are supplied, the Launch Rev Limiter RPM value is active.
MSD CAN (FOR USE WITH THE POWER GRID)			
Black	6		CAN LO
Gray	13		Reference Ground (Yellow Sleeve)
Red	16		CAN HI

PRESTART CHECK LIST

The only wires connected to the coil terminals are the MSD Orange to coil positive and Black to coil negative.

- The small Red wire of the MSD is connected to a switched 12 volt source.
- The MSD power leads are connected directly to the battery positive and negative terminals.
- The battery is connected and fully charged if not using an alternator.
- The engine is equipped with at least one ground strap to the chassis.
- Download the MSD App on your device.
 - Select your Ultra 6AL to pair device.
 - Default 8-Cylinder setting can be changed to 4 or 6-cylinder under the **Settings** tab, see 'Cylinder Select' in the MSD Mobile App section.

TROUBLESHOOTING

Every MSD Ignition undergoes numerous quality control checks including a four hour burn-in test. If you experience a problem with your MSD, our research has shown that the majority of problems are due to improper installation or poor connections.

The Troubleshooting section has several checks and tests you can perform to ensure proper installation and operation of the MSD. If you have any questions concerning your MSD, call our Customer Support Department at (888) 464-6553, Monday - Friday 7am - 4pm and Saturdays from 7am - 1pm MST.

LED

The LED monitors several operating conditions. When the ignition is functioning properly, the LED will illuminate green above idle speeds. If there is a problem with the ignition system the LED color will determine status, **see Table 3** and the following details for troubleshooting in this section.

LED COLOR	CONDITION
RED	Coil Shorted/Converter Shorted/Over temp
ORANGE	Key ON, Engine OFF (No RPM)
GREEN	Engine ON (RPM)

Table 3. LED Status

TACH/FUEL ADAPTERS

If your tachometer does not operate correctly or if you experience a no-run situation with your foreign vehicle you probably need an MSD Tach Adapter. **Table 4** lists common tachometers and if an Adapter is necessary.

TACHOMETER COMPATIBILITY LIST		
AFTERMARKET TACHOMETER	WHITE WIRE TRIGGER	MAGNETIC TRIGGER CONNECTOR
AUTOGAGE	8910	8920
AUTOMETER	NONE	NONE
FORD MOTORSPORTS	NONE	NONE
MALLORY	NONE	NONE
MOROSO	NONE	NONE
STEWART (Voltage triggered)	8910	8920
S.W. & BI TORX	NONE	NONE
SUN	8910	8920
VDO	NONE	NONE
AMC (JEEP)	8910	8920
CHRYSLER	8910	8920
FORD (Voltage triggered)	8910	8920
GENERAL MOTORS	Bypass In-line Filter	Bypass In-line filter
IMPORTS	8910	8920

Note: On the list above, the trigger wire on the tachometers that are marked NONE may be connected to the Gray Tach Output Wire on the MSD 6AL Ignition.

Table 4. Common Tachometer and Adapters

TACH ADAPTERS

There are two types of Tach Adapters:

PN 8920: If you are using the Magnetic Pickup connector (Green and Violet wires) to trigger the MSD, you will need the PN 8920.

PN 8910: If your tachometer was triggered from the coil negative terminal (voltage trigger) and you are using the White wire to trigger the MSD you will need the PN 8910.

NO-RUN ON FOREIGN VEHICLES

Some foreign vehicles with fuel injection systems may require an MSD Tach/Fuel Injection Adapter to run with an MSD Ultra 6 Series Ignition. This is because many of these systems use the same trigger source to operate the MSD, the tachometer and the fuel injection. This results in a voltage

signal that is too low to accurately trigger the fuel injection. To fix this, an MSD Tach Adapter, PN 8910, will remedy the problem on the majority of vehicles. If the PN 8910 does not fix the problem, the PN 8910-EIS will be required.

Note: Toyota models and Ford Probes will require the PN 8910EIS Adapter.

INOPERATIVE TACHOMETERS

If your tachometer fails to operate with the MSD installed you may need an MSD Tach Adapter. Before getting an Adapter, try connecting your tachometer trigger wire to the Gray tach wire of the MSD. This output produces a 12 volt, square wave (see 'Tachometers' on page 2). If the tach still does not operate, you will need a Tach Adapter.

BALLAST RESISTOR

If you have a current trigger tach (originally coil positive) and use the White wire of the MSD, you can purchase a Chrysler Dual Ballast Resistor (used from 1973 - 1976) and wire it as shown in **Figure 1**.

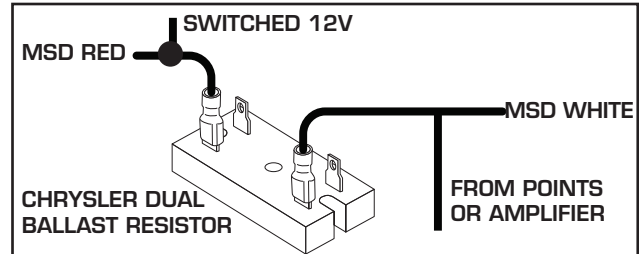

Figure 1 Wiring the Dual Ballast Resistor

ENGINE RUN-ON

If your engine continues to run even when the ignition is turned Off, you are experiencing engine Run-On. This usually only occurs on older vehicles with an external voltage regulator. Because the MSD receives power directly from the battery, it does not require much current to keep the unit energized. If you are experiencing run-on, it is due to a small amount of voltage going through the charging lamp indicator and feeding the small Red wire even if the key is turned off.

Early Ford and GM: To solve the Run-On problem, a Diode is supplied with the MSD in the parts bag. By installing this Diode in-line of the wire that goes to the Charging indicator, the voltage is kept from entering the MSD. **Figure 2** shows the proper installation for early Ford and GM vehicles.

Note: Diodes are used to allow voltage to flow only one way. Make sure the Diode is installed facing the proper direction (as shown in **Figure 2**).

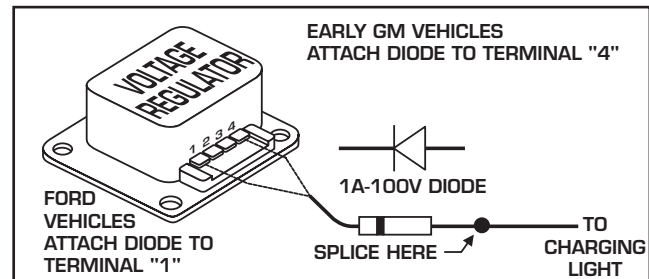

Figure 2 Installing the Diode to a GM or Ford Vehicle

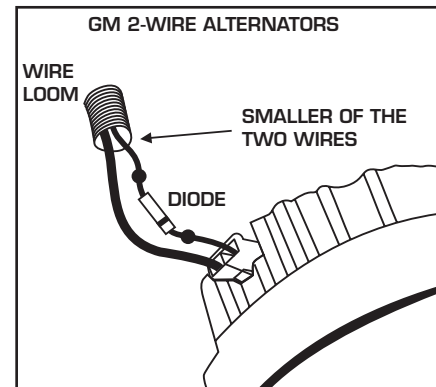

Figure 3 Installing the Diode to a 1973-1983 GM Vehicle

Ford: Install the Diode in-line to the wire going to the "1" terminal.

GM: Install the Diode in-line to the wire going to terminal #4.

GM: 1973 - 1983 with Delcotron Alternators.

GM: Delcotron Alternators use an internal voltage regulator. Install the Diode in-line on the smallest wire exiting the alternator (**Figure 3**). It is usually a Brown wire.

Most other applications: On other applications where engine Run-On is experienced, a diode can be put in-line to the MSD's small Red wire (**Figure 4**). This will keep voltage from leaking through to the MSD unit

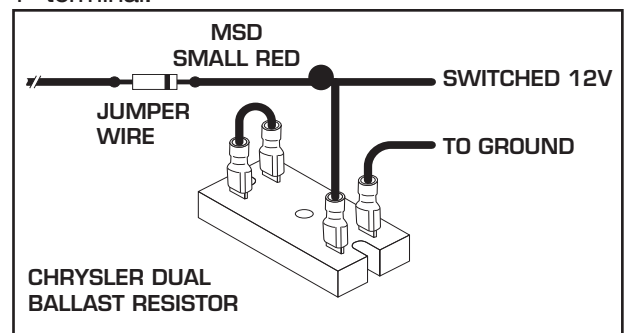

Figure 4 Wiring the Dual Ballast Resistor for Run-On

MSD MOBILE APP

The MSD App controls all the features of the MSD Ultra 6AL controller using your device's bluetooth connection. The information that follows will briefly explain the features in the app.

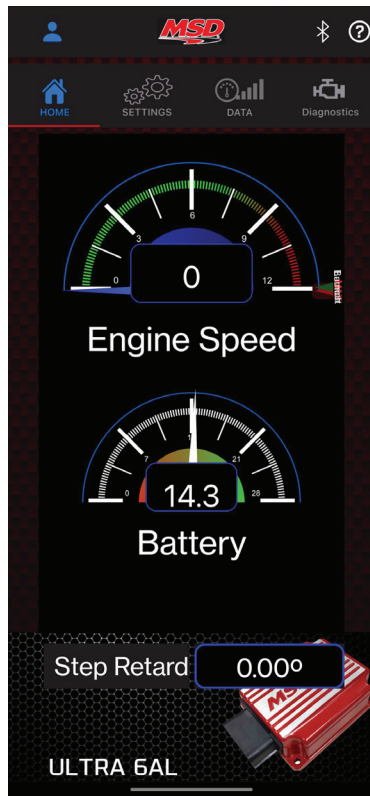

Figure 5. Home Screen

HOME

The Home screen (**Figure 5**) displays the Engine Speed with Burnout, Rev and Launch RPMs. Also displayed are the Battery voltage, degree of the Step Retard and current product installed.

The Burnout and Rev Limit markers can be updated right from the home screen. Simply tap on the feature and use the slider to set the desired RPM

SETTINGS

In the settings screen are the adjustable parameters. See **Figure 6** for a view of all settings.

REV LIMITER

Launch Rev Limiter: This is the maximum RPM the engine will be allowed to reach when 12 volts is applied to the dark blue wire. Adjustable from 2000 to 12000 RPM.

Launch Rev Limit Latch

When the Launch Rev Limit Latch is OFF, the Launch RPM (2 step) will activate any time the RPM is at or above the set Launch RPM. When setting is ON, the engine rpm must fall below 7/8 of the launch limit setting while 12 volts is applied to the Dark Blue wire to engage

the Launch Limiter. The Launch RPM cannot become active unless the RPM falls below 7/8 of the set RPM.

For example: If set at 4000 RPM and the launch wire is activated, the launch limiter can only come on if the RPM falls below 3500. This prevents accidental activation while at high RPM (such as a faulty launch switch activating or activating it with the clutch during the run). This allows clutch cars to wire the Dark Blue wire directly to the clutch switch without the need to use a relay. If Latching is disabled, the Launch Rev Limiter will be engaged anytime the Dark Blue wire receives 12 volts (such as during each shift) regardless of engine rpm.

Burn Out Rev Limiter: Activated when 12 volts are applied to the Light Blue wire. It overrides all other rev limiters and is typically connected to the line lock solenoid. It is adjustable from 2000 to 12000 RPM.

Maximum Rev Limiter: This is the over rev limit designed to protect the engine from damage. It is adjustable from 2000 to 12000 rpm.

STEP RETARD

Step Retard (Deg): Activated when 12 volts are applied to the Pink wire (nitrous input). Ignition timing Adjustable from 0 to 30 degrees.

On Ramp Time (Sec): This is the time to reach full or total retard. Adjustable from 0 to 5 seconds.

Example: If 10 degrees of total retard is set with 1 second of ramp

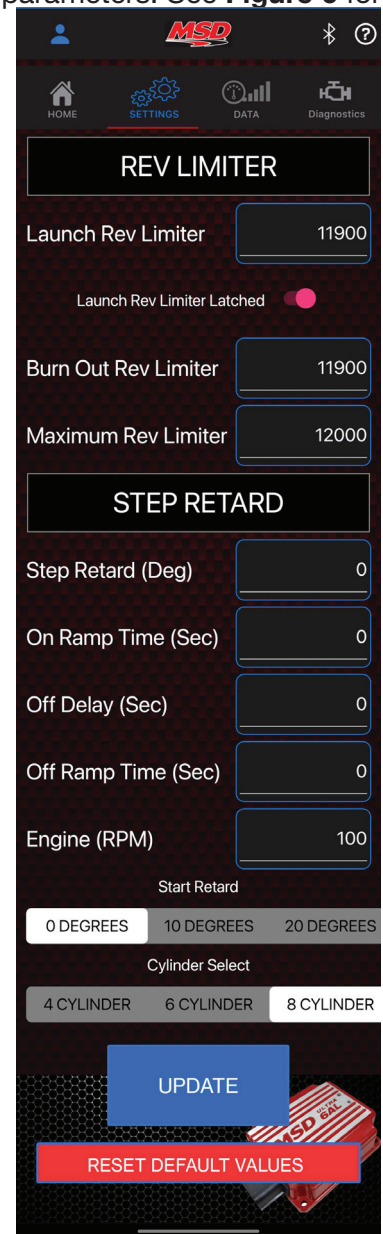

Figure 6. Settings Screen

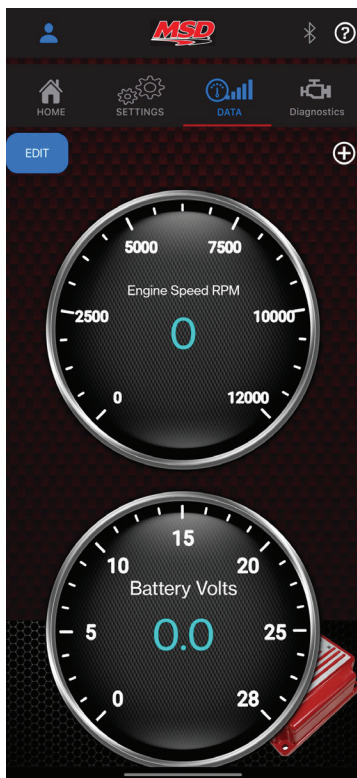

Figure 7. Data Screen

time, the MSD will retard 1degree every 0.1 seconds until the full 10 degrees of timing is pulled. A '0' (zero) setting will cause an immediate timing retard or total retard of 10 degrees.

Off Delay (Sec): The time the Total Retard remains in effect after the “Step Retard” is deactivated. Adjustable from 0 to 5 seconds. This will also delay the “Off Ramp Time” from starting - meaning that it is additive with respect to the Off-Ramp Time.

Off Ramp Time (Sec): This will slowly remove the effect of the Total Retard - effectively ramping timing back into the motor instead of adding it instantaneously. Timing will start ramping back in after the “Off Delay” has expired. Adjustable from 0 to 5 seconds.

Engine (RPM): This is the minimum engine speed that must be met to retard the timing. Adjustable from 0 to 10000 RPM.

START RETARD

Degree of retard set to be pulled during engine cranking (from 0-600 RPM). Select from '0', '10' & '20' Degrees.

CYLINDER SELECT

Select the cylinder count of your current vehicle of 4, 6 or 8 CYLINDERS.

UPDATE

Sends updated values/parameters to the connected unit.

RESET DEFAULT VALUES

Resets the application values

DATA TAB

A custom graph, digital readout or gauge can be created from a selection of parameters (Table 5) added by using the plus icon (+). (Figure 7) Each gauge or digital readout can be moved up or down, custom colors can be selected and display types can be changed as well as units, when applicable, by using the Edit button. (Figure 8)

NOTE: As the MSD temperature reaches an unsafe operating temperature, the spark energy decreases then cuts off when the ECU reaches its threshold of 140°C/284°F.

DIAGNOSTICS

The Ultra MSD notifies the user if there are any alerts with the LED and in app alerts. (Figure 9)

ALERTS	STATUS LED
Coil Shorted	RED
Converter Shorted	RED
Coil Shorted to Battery	RED
Over Temperature	RED
Coil Open	GREEN
Open Load	GREEN
Converter Low	GREEN
Converter Fault	GREEN
EEPROM Error	GREEN

Table 6. MSD Ultra Alert List

ALERTS

Read Alerts: Alerts are listed from current and previous occurrences and remain until they are resolved and erased. (Table 6)

Clear Alerts: This will erase the alerts.

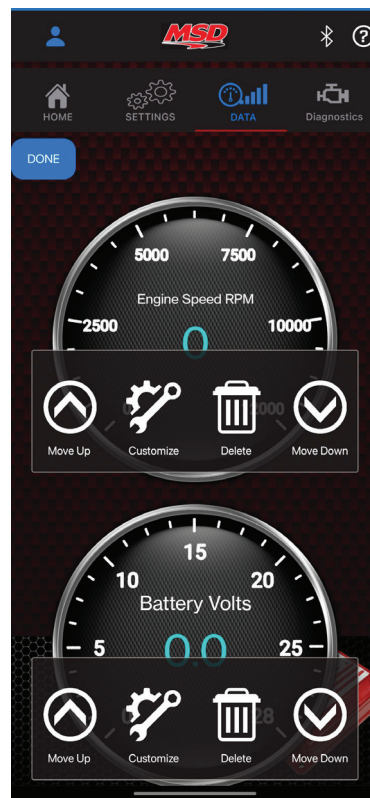

Figure 8. Display Editing

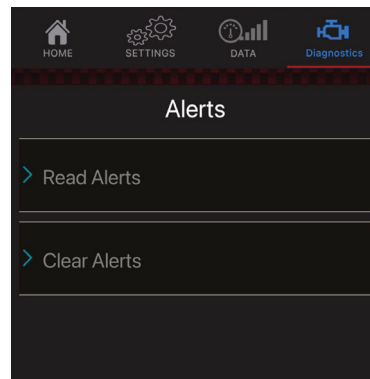

Figure 9. Alerts Screen

PARAMETERS	DESCRIPTION
Engine Speed	Engine speed in RPM.
Temperature	MSD temperature in either Celsius or Fahrenheit.
Battery	Voltage being supplied to the unit.
Ignition Retard	Degrees of total retard pulled from ignition timing.
Rev Limit	Displays set Rev Limit.
Rev Limit Source	Indicates which source will be limiting the motor. It will be Key Off when connected via Bluetooth, Launch when the launch wire is activated, Burnout over rides other Rev limits when activated or Maximum any other time.
Cylinders	Cylinder count selection (4, 6 or 8).
Start Retard	Degree of retard set to be pulled during engine cranking (from 0-600 rpm) Selection from the settings of '0'.
Step Input	Displays Step input status ON/OFF.
Burnout Input	Displays Burnout input status ON/OFF.
Launch Input	Displays Launch input status ON/OFF.
Target Energy	Displays target energy in Millijoules
Alerts Number	Shows alert count.

Table 5. MSD ULTRA 6AL Parameters

PAIRING MOBILE DEVICE TO THE MSD

When pairing your mobile device to the MSD Ultra 6AL Plus, make sure there is power to the ignition and the LEDs are on.

Before starting the App:

1. Press the Green reset button until the Wi-Fi LED blinks Red twice, then turns off (approximately 5 seconds)
2. Press the button again.
3. The Wi-Fi LED will flash Blue/Orange/Red and is now in pairing mode.
4. Open the App and it will pair with the MSD after permissions are granted, see permissions below for Apple and Android

FOR APPLE USERS:

Select 'OK' on the alert box to connect the Ultra 6AL Plus. (Figure 10)

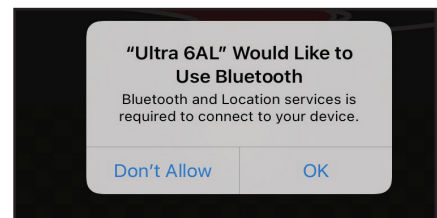

Figure 10 Alert Box (Apple)

FOR ANDROID USERS:

Select 'OK' on the Alert Box to enable the bluetooth services. (Figure 11)

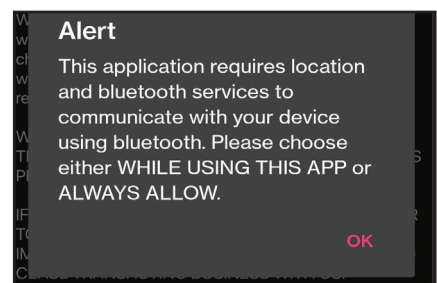

Figure 11 Alert Box (Android)

Select 'Allow' in the location box to detect the MSD bluetooth (Figure 12). This will enable Bluetooth communication with your device.

Once paired, the MSD App Home Screen (Figure 13) will appear and settings can be modified for your application.

MSD APP CONNECTION

The MSD app can pair more than one unit, so confirming one or an additional unit will ensure it is added to your profile.

To connect a different MSD, such as the PN 6423, the App will need to be restarted otherwise an error will be displayed. (Figure 14)

If a 'Security check failed' window appears, proceed to follow instructions to reset and reconnect to the unit.

MSD VIEW

The MSD Ultra 6AL Plus settings can also be viewed and updated via the MSD View software using the Power Grid (PN 7730) CAN Bus, if it is already installed on the vehicle.

DISTRIBUTOR SET UP

The MSD Ultra 6AL has a start retard feature which can only be used if the distributor is locked out. (no mechanical advance).

The MSD Ultra 6AL has a Step Retard feature for Nitrous and or Boosted applications than can be set up to 30 degrees, if the retard setting is over 10 degrees an adjustable rotor will be needed.

For MSD billet distributors the 8421 and the 84211 is available for this purpose, setting the adjustable rotor to 15 degrees opposite distributor rotation will correct the rotor phasing.

Distributors that we do not have an adjustable rotor for do not adjust the retard above 10 degrees.

MISSES AND INTERMITTENT PROBLEMS

Experience at the races has shown that if your engine is experiencing a miss or hesitation at higher rpm, it is usually not directly the ignition. Most probable causes include faulty wiring, a coil or plug wire failure, arcing from the cap or boot plug to ground or spark ionization inside the cap. Several items to inspect are:

- Always inspect the plug wires at the cap and at the plug for a tight connection and visually inspect for cuts, abrasions or burns.
 - Inspect the Primary Coil Wire connections. Because the MSD is a Capacitive Discharge ignition and it receives a direct 12 volt source from the battery, there will not be any voltage at the Coil Positive (+) terminal even with the key turned On. During cranking or while the engine is running, very high voltage will be present and no test equipment should be connected.
- WARNING:** Do not touch the coil terminals during cranking or while the engine is running.
- Make sure that the battery is fully charged and the connections are clean and tight. If you are not running an alternator this is an imperative check. If the battery voltage falls below 10 volts during a race, the MSD output voltage will drop.
 - Is the engine running lean? Inspect the spark plugs and complete fuel system.
 - Inspect all wiring connections for corrosion or damage. Remember to always use proper connections followed by soldering and seal the connections completely.

If everything checks positive, use the following procedure to test the ignition for spark. MSD also offers an Ignition Tester, PN 8998 or PN 89981. This tool allows you to check your complete ignition system while it is in the car as well as the operation of rpm limits, activated switches and shift lights.

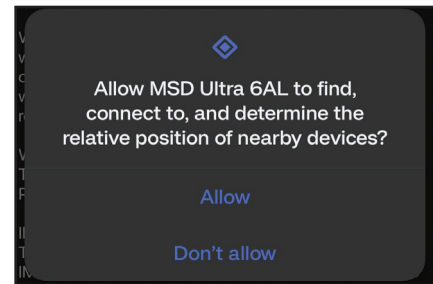

Figure 12 Location Box

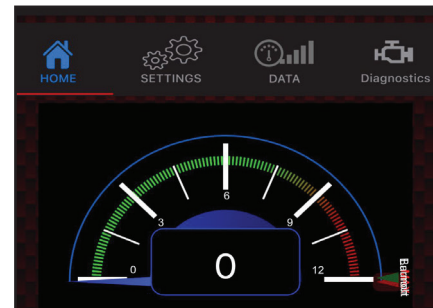

Figure 13 Home Screen

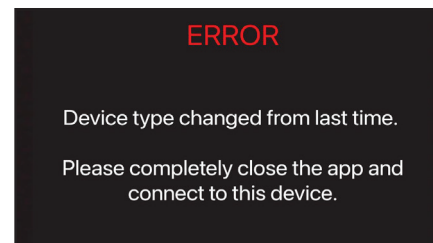

Figure 14 App Error

CHECKING FOR SPARK

White wire trigger:

If you are using the white wire (points or electronic amplifier) of the MSD to trigger the ignition, follow these steps (Figure 15):

1. Make sure the ignition switch is in the "Off" position.
2. Remove the coil wire from the distributor cap and set the terminal approximately 1/2" from a good ground.
3. Disconnect the MSD White trigger wire from the distributor points or the ignition amplifier.
4. Turn the ignition to the On position. **Do Not Crank the Engine.**
5. Tap the White wire to ground several times. Each time you pull the wire from ground, a spark should jump from the coil wire to ground.

If spark is present, the ignition is working properly. If there is no spark skip to step 6.

Magnetic Pickup trigger:

1. Make sure the ignition switch is in the "Off" position.
2. Remove the coil wire from the distributor cap and set the terminal approximately 1/2" from ground.
3. Disconnect the MSD magnetic pickup wires from the distributor.
4. Turn the ignition to the On position. Do not crank the engine.
5. With a small jumper wire, short the MSD's Green and Violet magnetic pickup wires together several times (Figure 16). Each time you break this short, a spark should jump from the coil wire to ground. If spark is present, the ignition is working properly. If there is no spark skip to step 6.

6. If there is no spark:

- A. Inspect all of the wiring.
- B. Substitute another coil and repeat the test. If there is now spark, the coil is at fault.
- C. If there is still no spark, check to make sure there are 12 volts on the small Red wire from the MSD when the key is in the On position. If 12 volts are not present, find another switched 12 volt source and repeat the test.
- D. If, after following the test procedures and inspecting all of the wiring, there is still no spark, the MSD Ignition is in need of repair. See the Warranty and Service section for information.

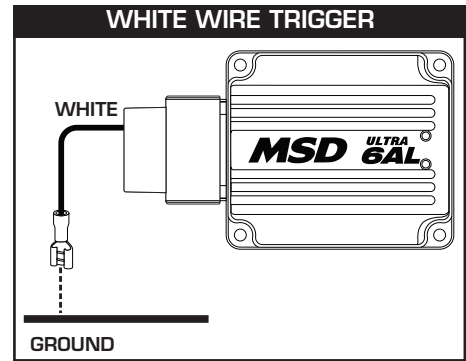

Figure 15 Checking for Spark with the White Wire

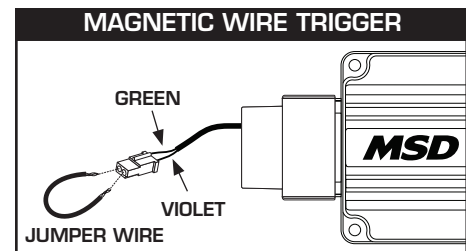
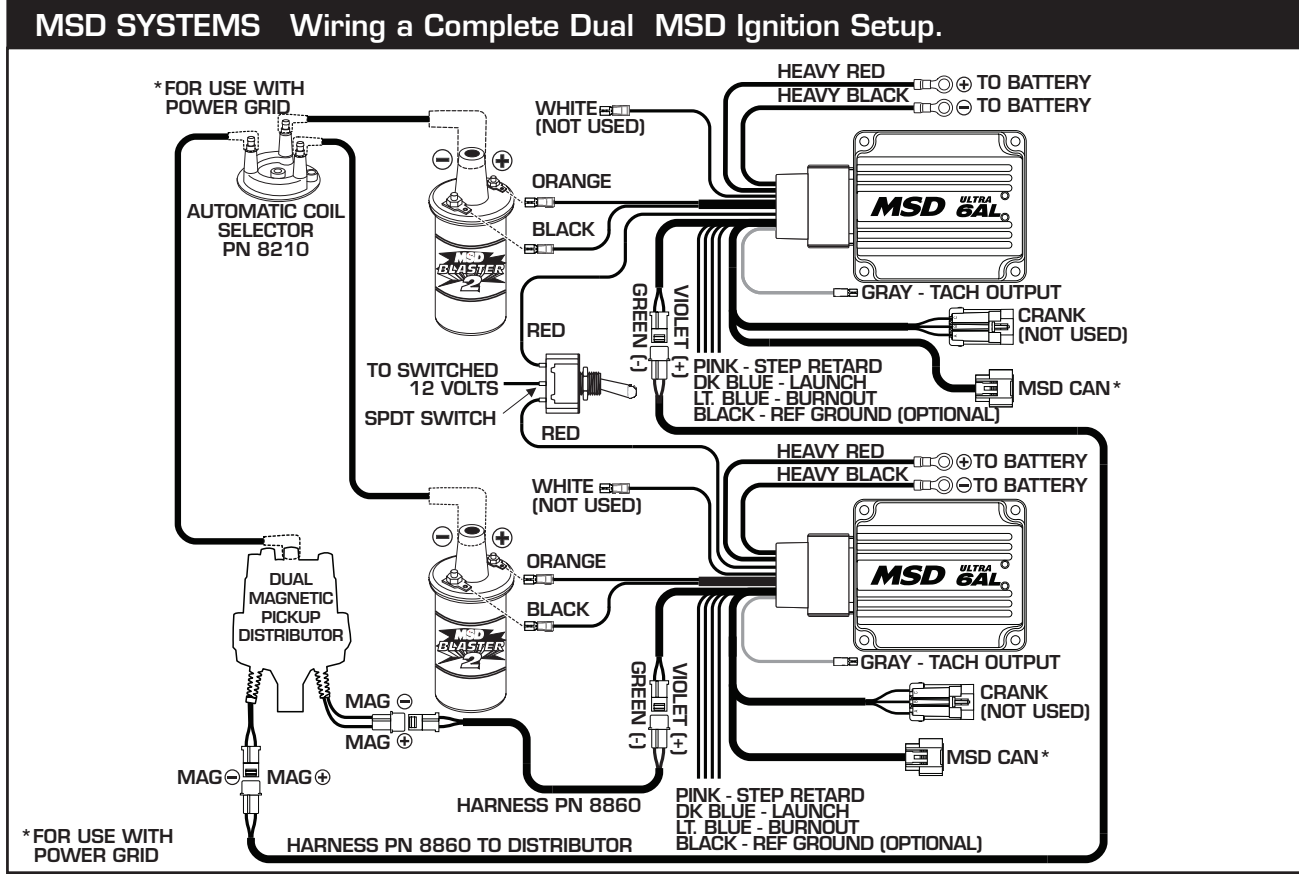
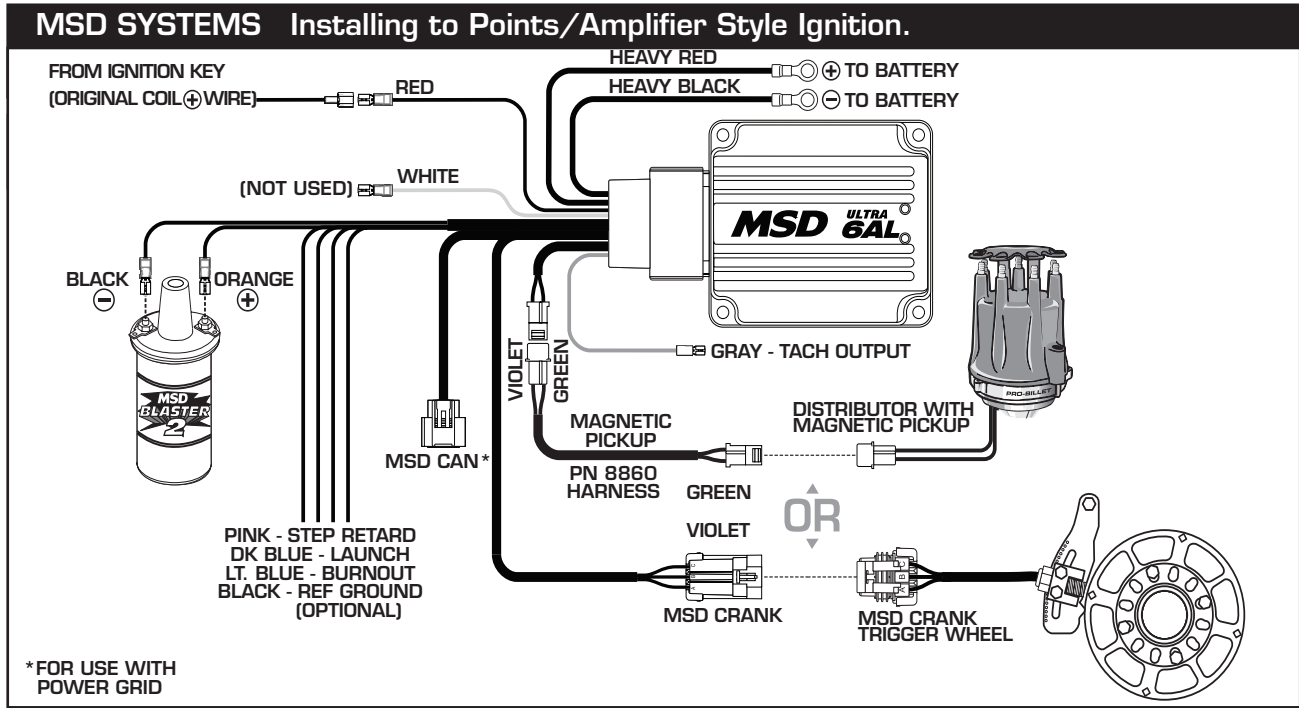

Figure 16 Checking for Spark with the Mag Pickup

The following wiring diagrams illustrate numerous installations on different vehicles and applications. If you experience difficulties when installing your MSD, contact our Customer Support Department at (866) 464-6553, Monday - Friday 7am - 4pm and Saturdays from 7am - 1pm MST or e-mail us at: msdtech@msdperformance.com

If this unit will be used for timing curves of any kind over 10 degrees, an adjustable rotor & distributor must be locked out. For certain applications, the MSD Ultra Plus can be used as an ignition amplifier with limiter functions and no more than 10 degrees of step retard. If a PowerGrid is used, the CAN pigtail could be used to view the Ultra settings in MSD View.



GM IGNITIONS Wiring a Dual Connector Coil.

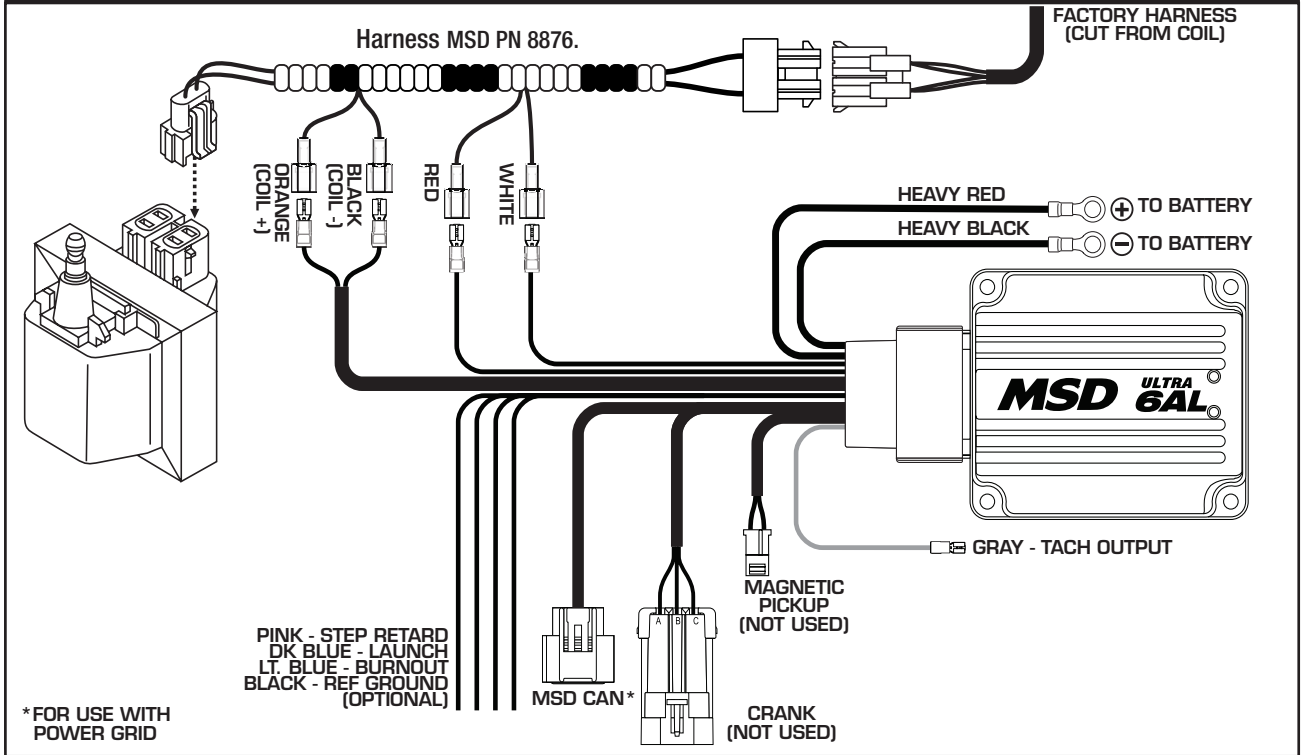

GM IGNITIONS Wiring the 1996 and up single connector coil without harness.

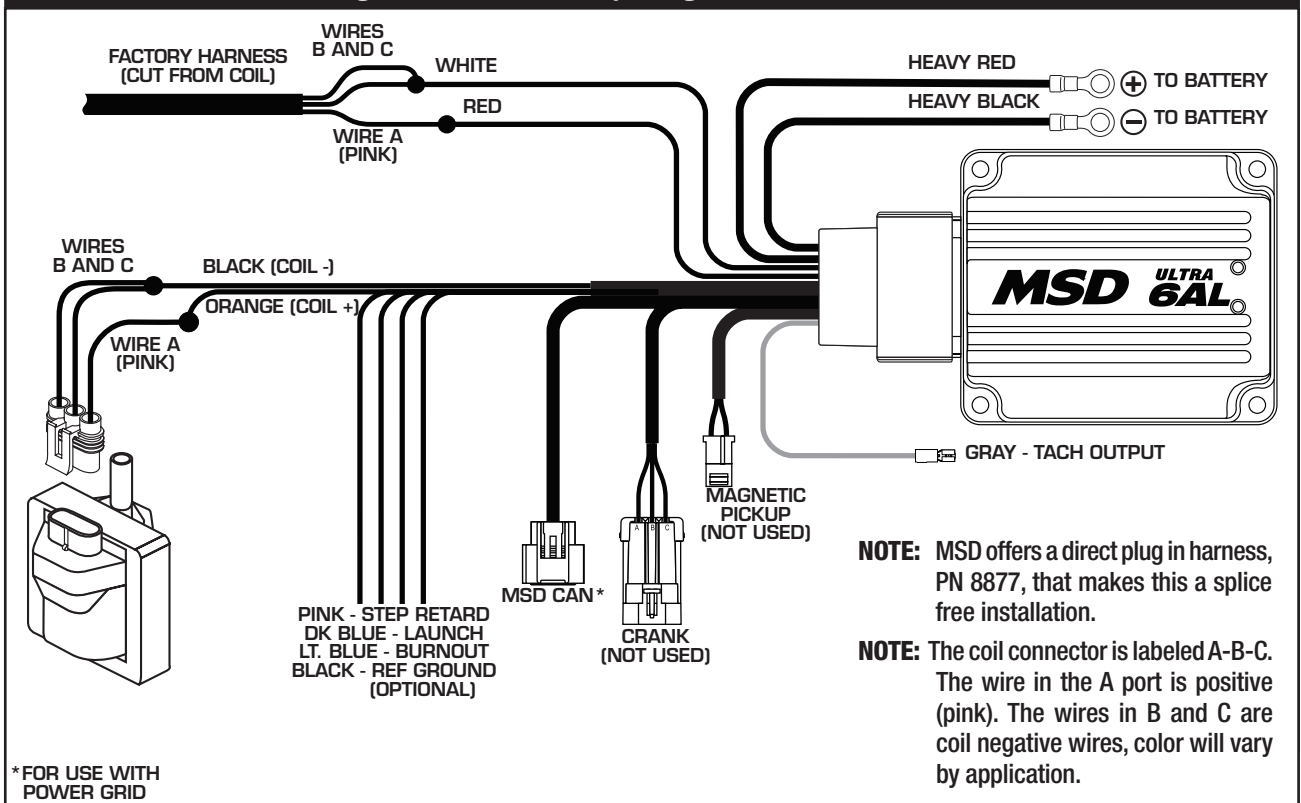

GM IGNITIONS Wiring with an MSD Wiring Harness.

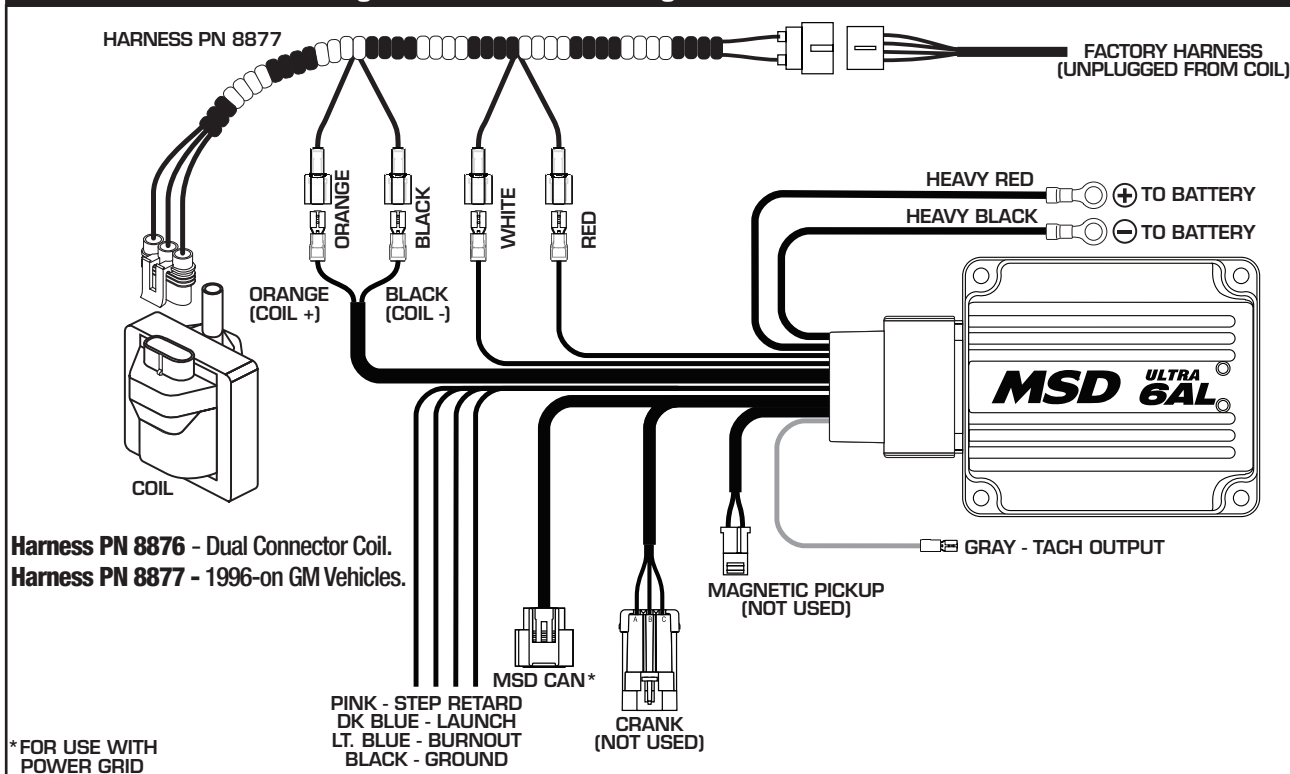

GM IGNITIONS GM Large Cap HEI Distributors

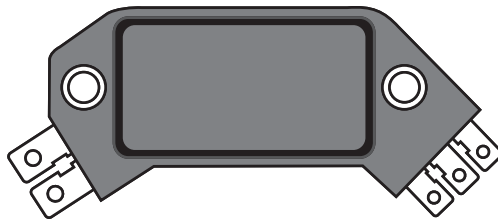
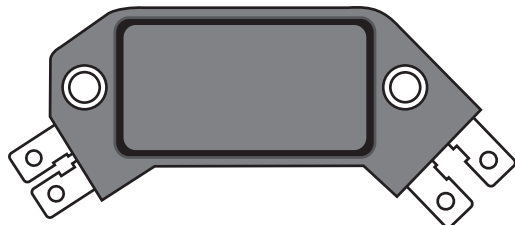

There are three different large cap HEI distributors. To identify which of the following diagrams fit your specific application, remove the distributor cap and rotor and locate the ignition module at the base of the distributor. Count the number of terminals on both ends of the module and follow the corresponding diagram. GM used 4, 5, and 7-pin modules in these distributors.

NOTE: Some 5-pin models may experience a hesitation or stall on deceleration. If this occurs, contact MSD Tech Line for the required bolt-in diode to correct the problem. MSD Tech Line (888) 464-6553.

GM IGNITIONS Wiring an HEI 4-pin Module (Magnetic Pickup Trigger).

NOTE: The GM Ignition Module and condenser are removed and replaced with the supplied PN 8861 Harness.

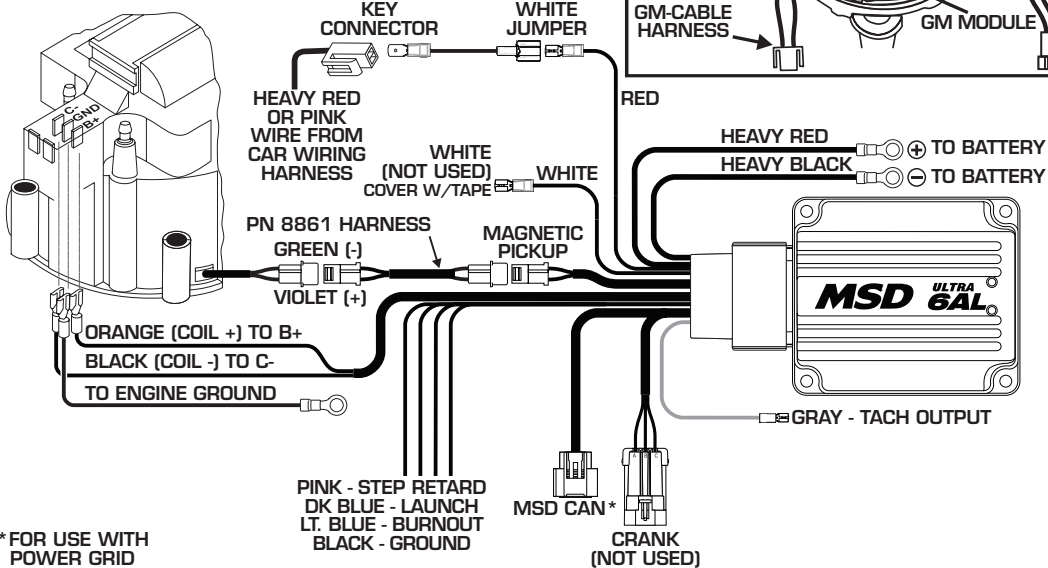
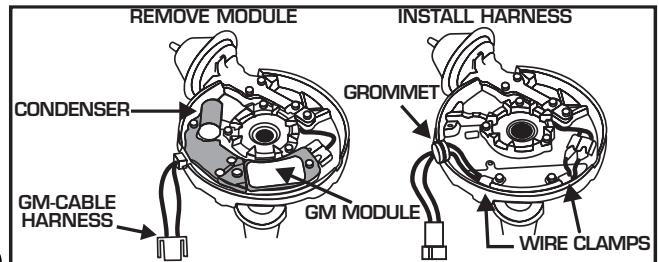

GM IGNITIONS Wiring an HEI 5 or 7-pin Module (Amplifier Trigger).

NOTE: Some 5-pin models may experience a hesitation or stall on deceleration. If this occurs, contact MSD Tech Line for the required bolt-in diode to correct the problem. MSD Tech Line (888) 464-6553.

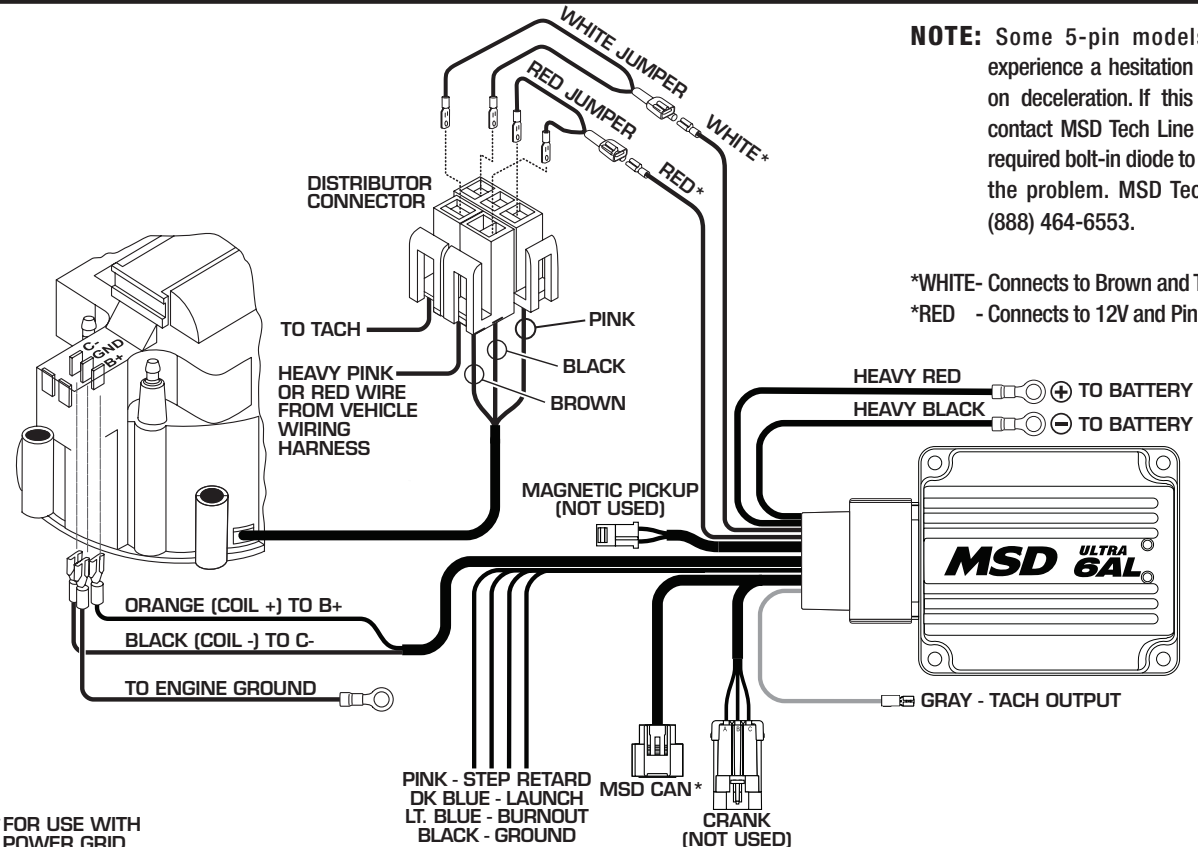

FORD IGNITIONS Wiring a Ford DuraSpark using White Wire Trigger.

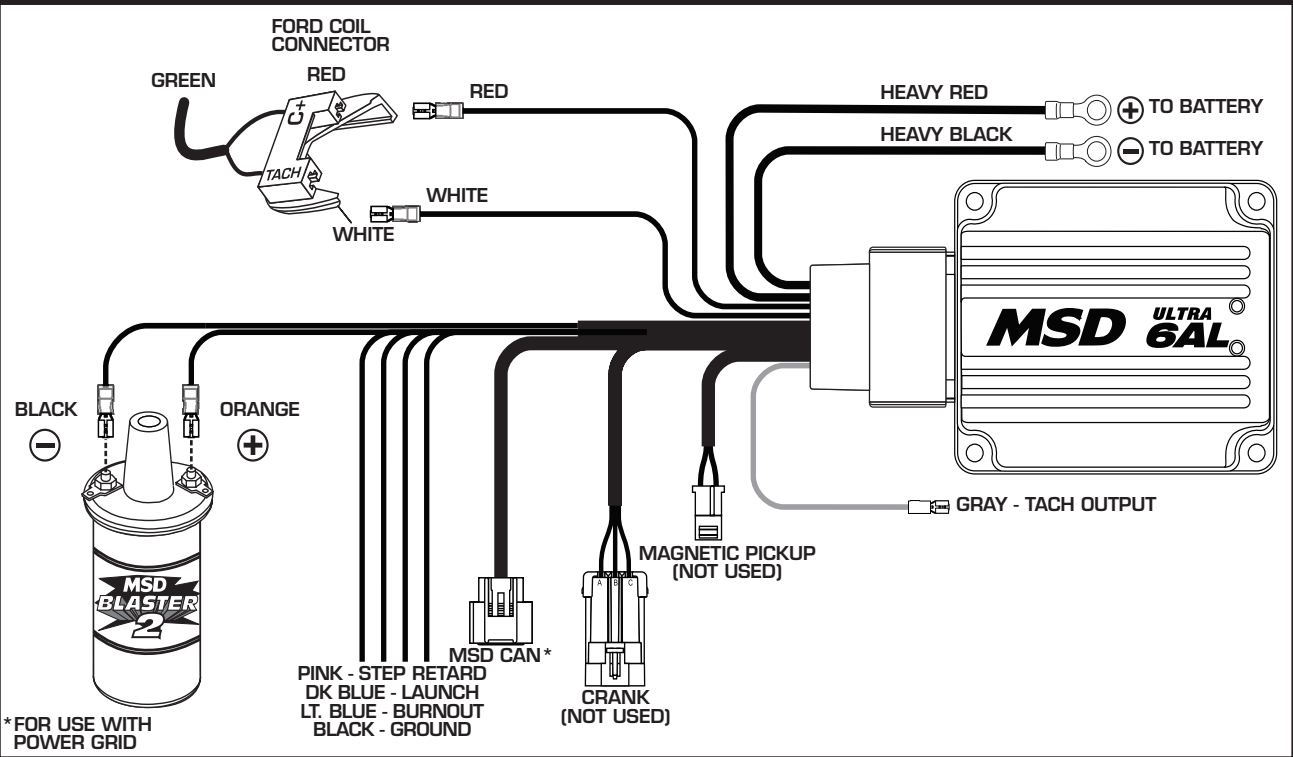

FORD IGNITIONS Wiring a Ford DuraSpark using Magnetic Pickup Trigger.

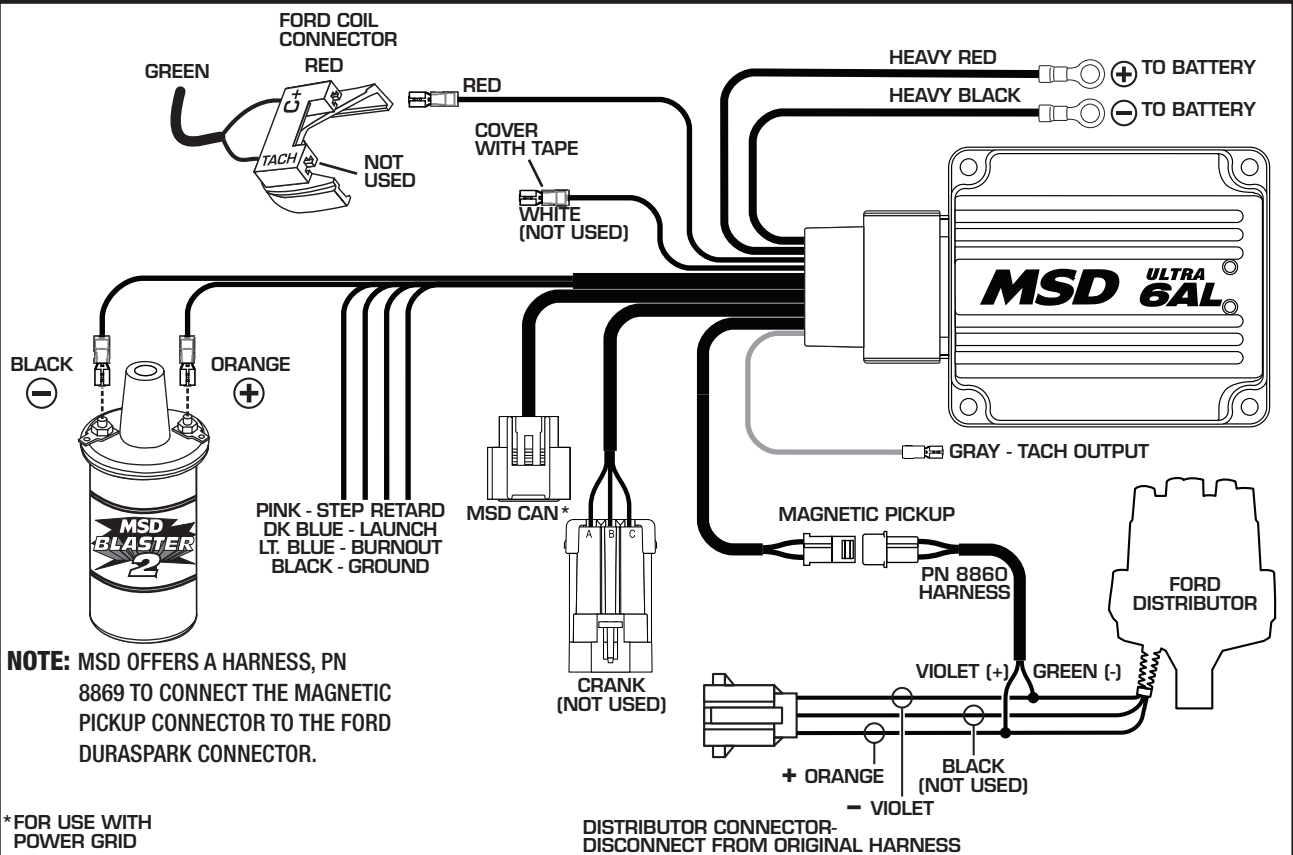

FORD IGNITIONS Wiring a Ford TFI with Harness, PN 8874.

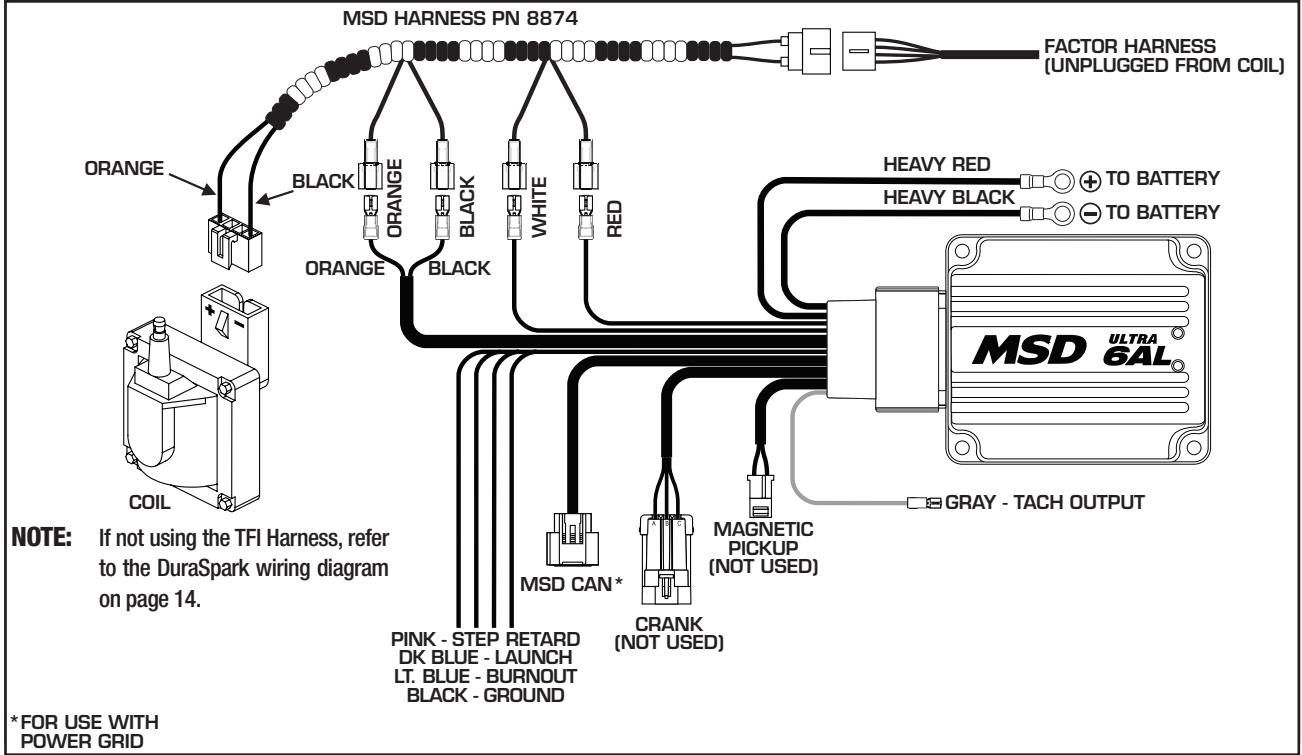

CHRYSLER IGNITIONS Wiring a Chrysler Electronic Ignition using Magnetic Pickup Trigger.

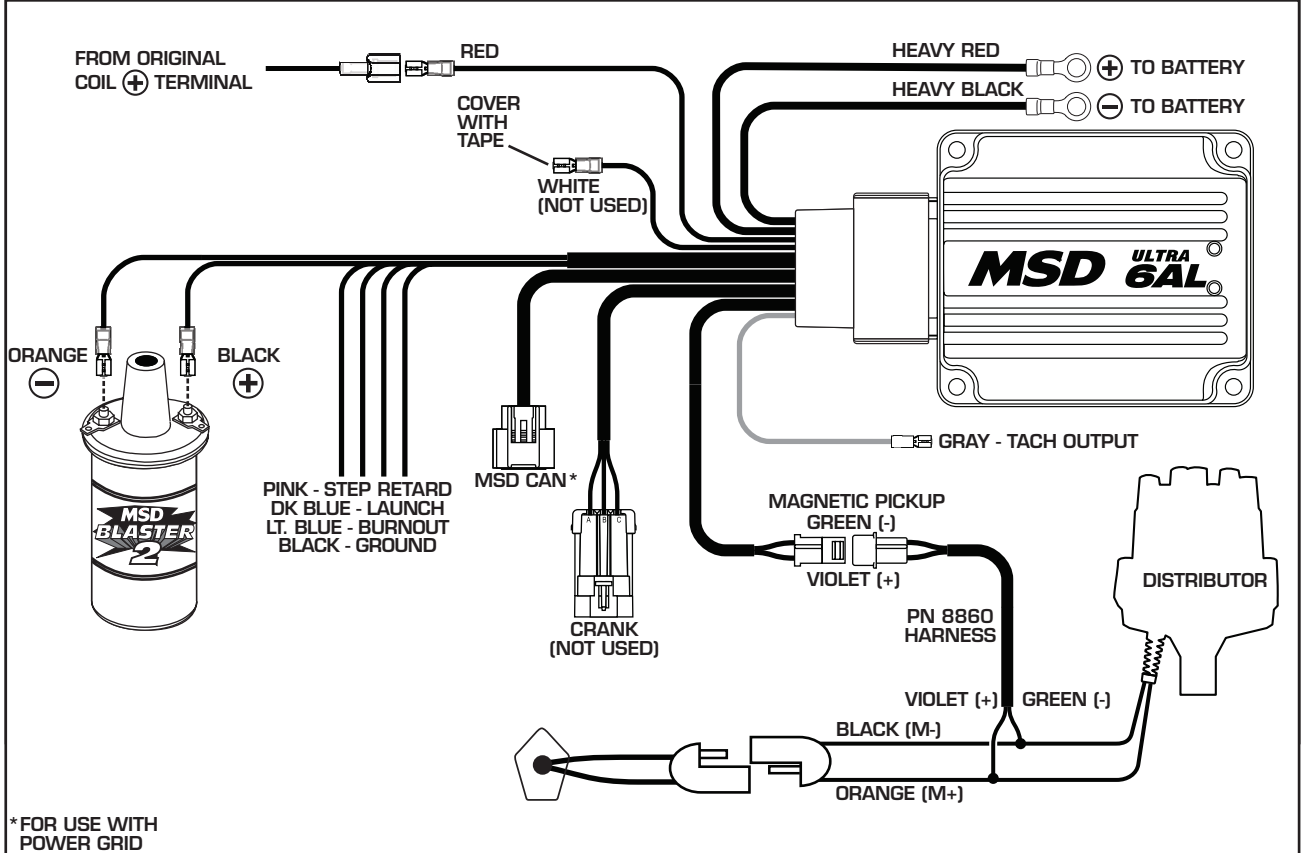

CHRYSLER IGNITIONS Wiring a Late Model Dodge with 2-pin connector.

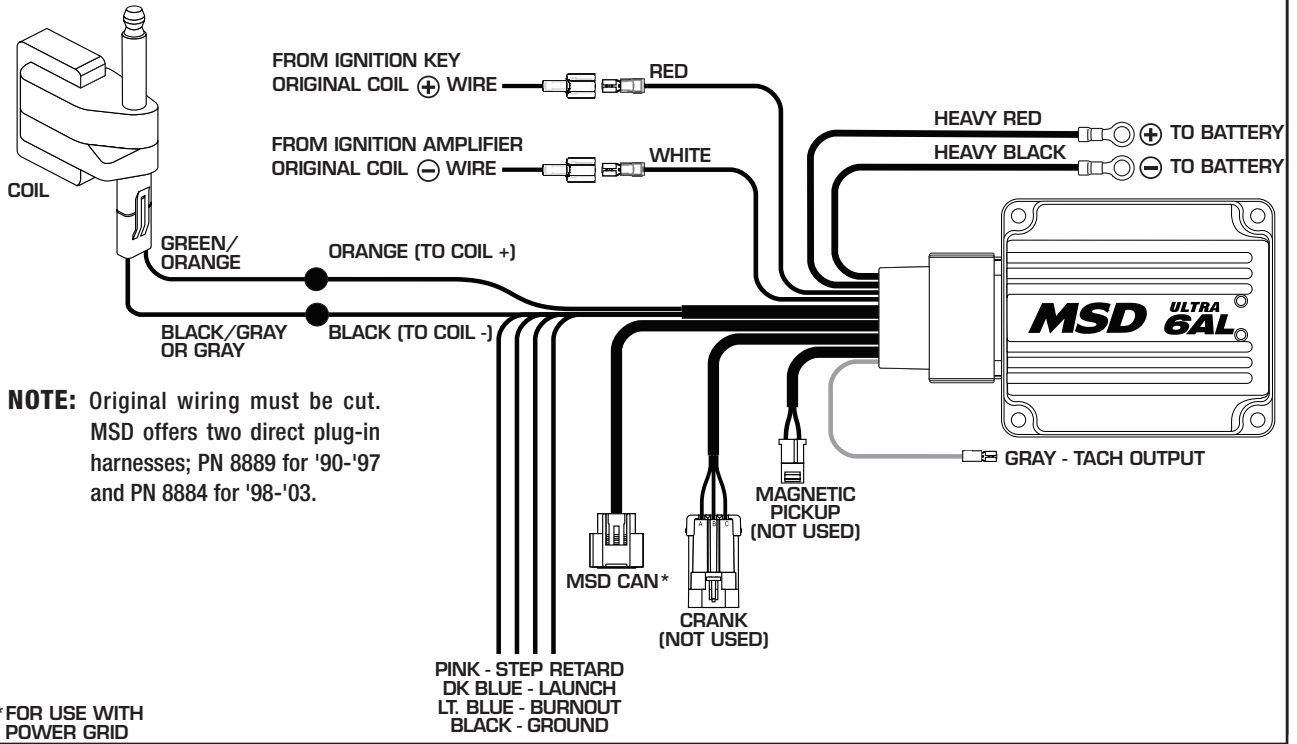

GENERAL IMPORT WIRING

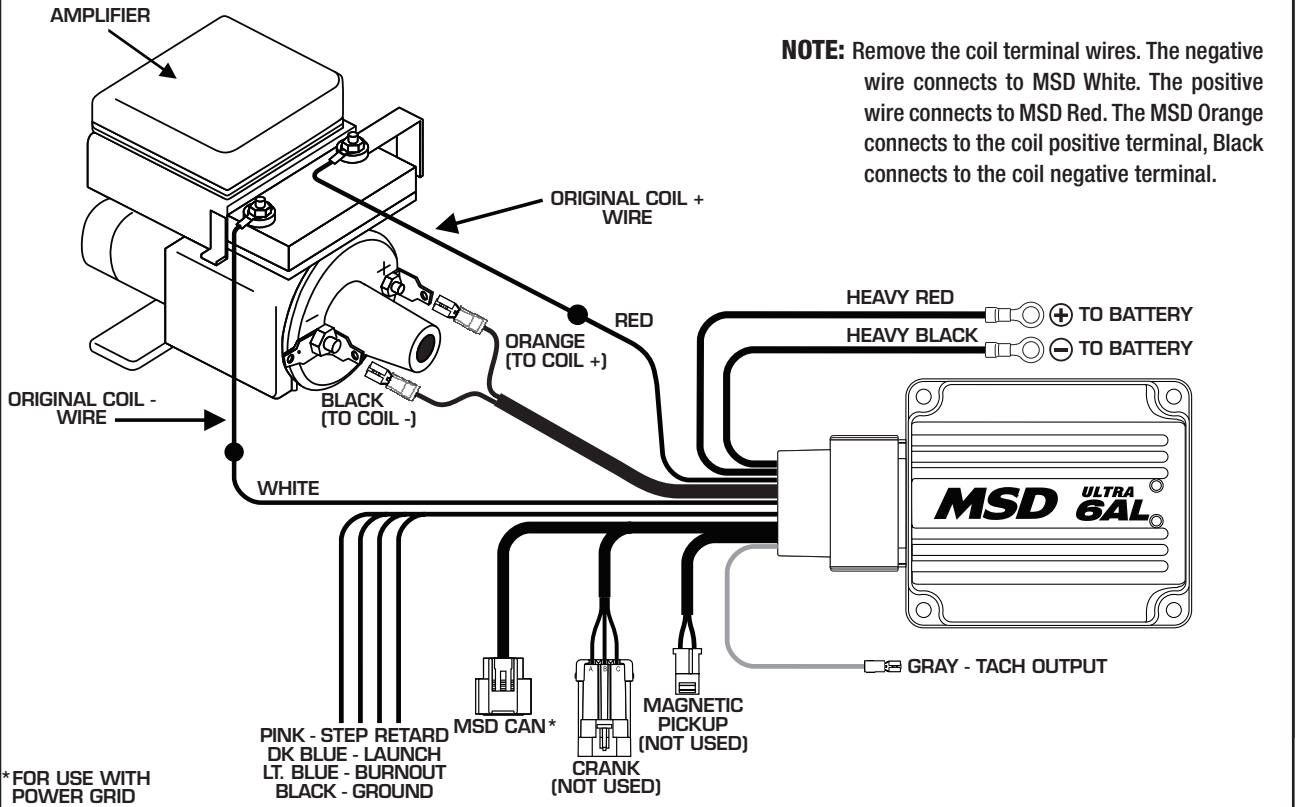

AFTERMARKET COMPONENTS Wiring a Mallory Unilite or 9000 Series using Points Trigger.

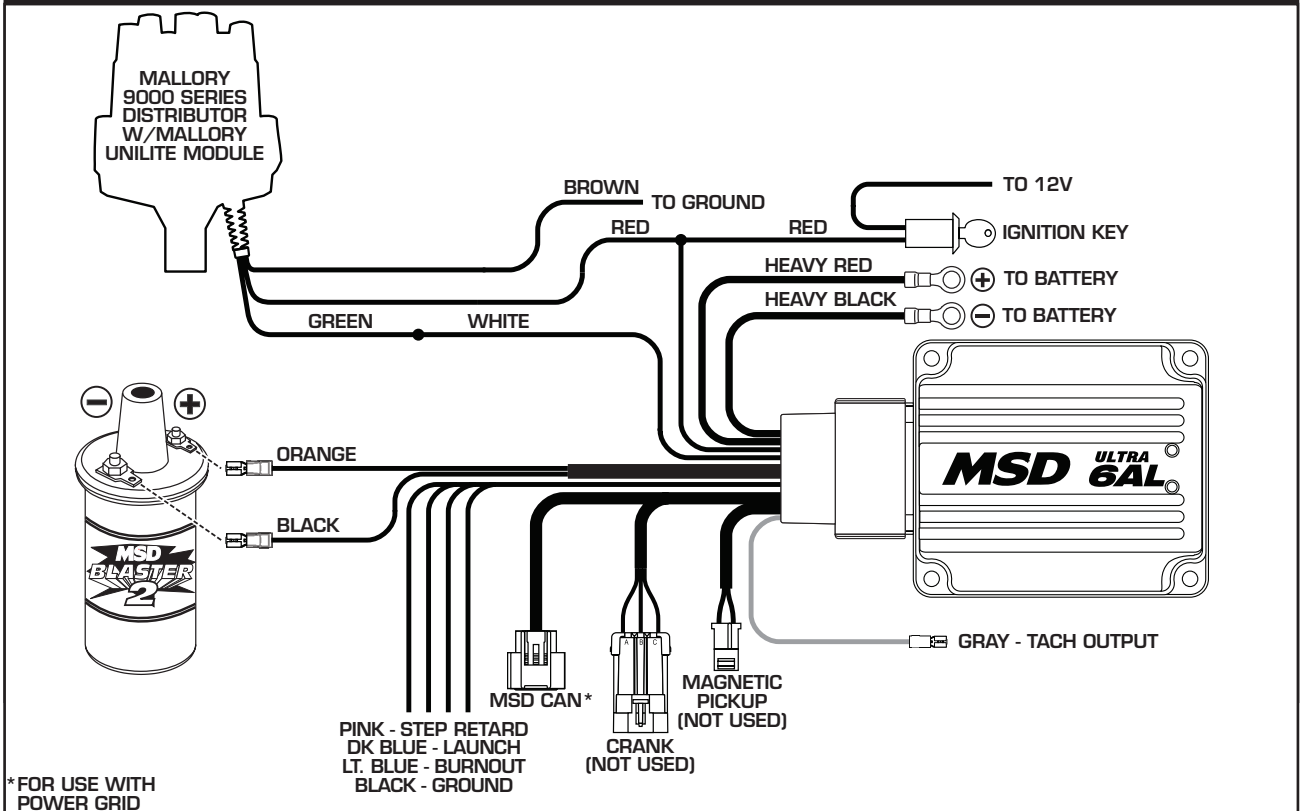

AFTERMARKET COMPONENTS Wiring a Mallory Unilite or 9000 Series using Points Trigger.

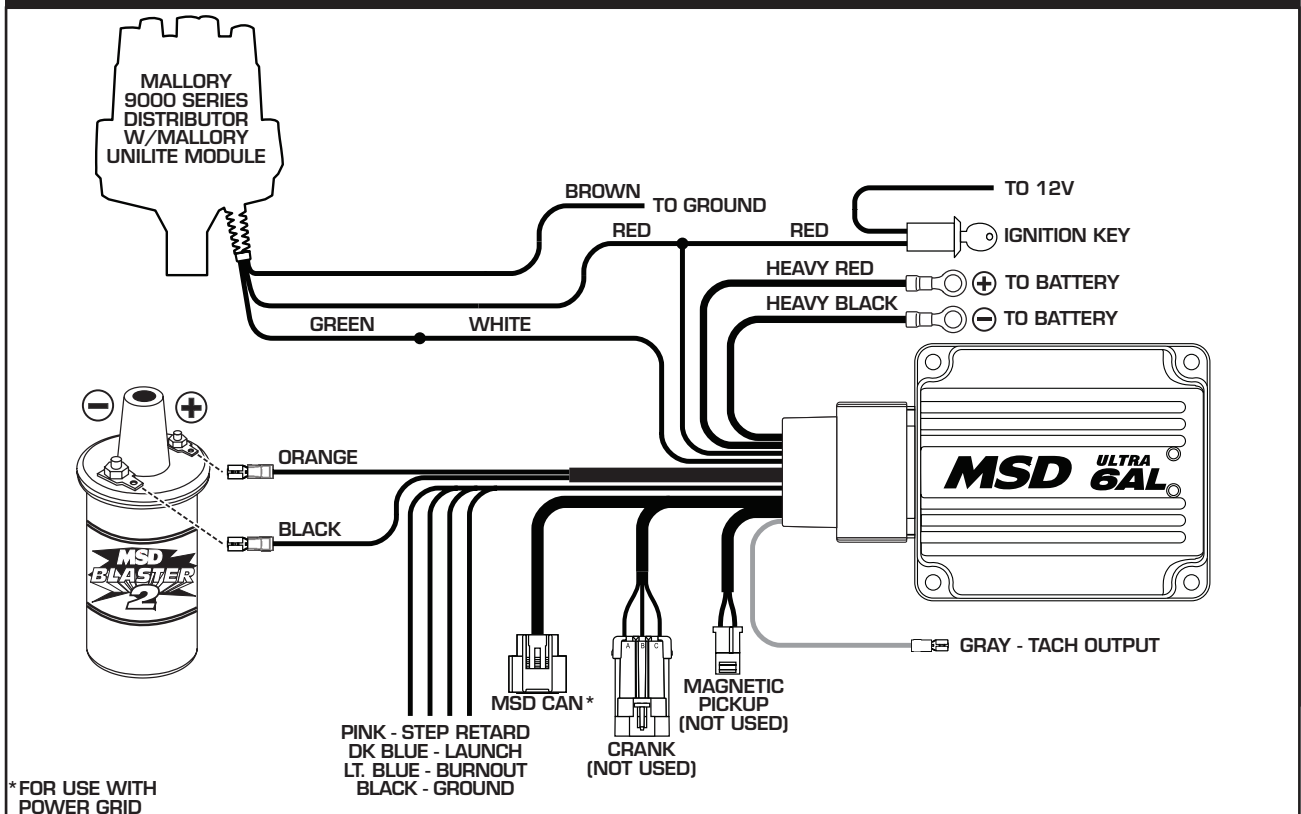

AFTERMARKET COMPONENTS Wiring a Mallory 9000 Series using Magnetic Pickup.

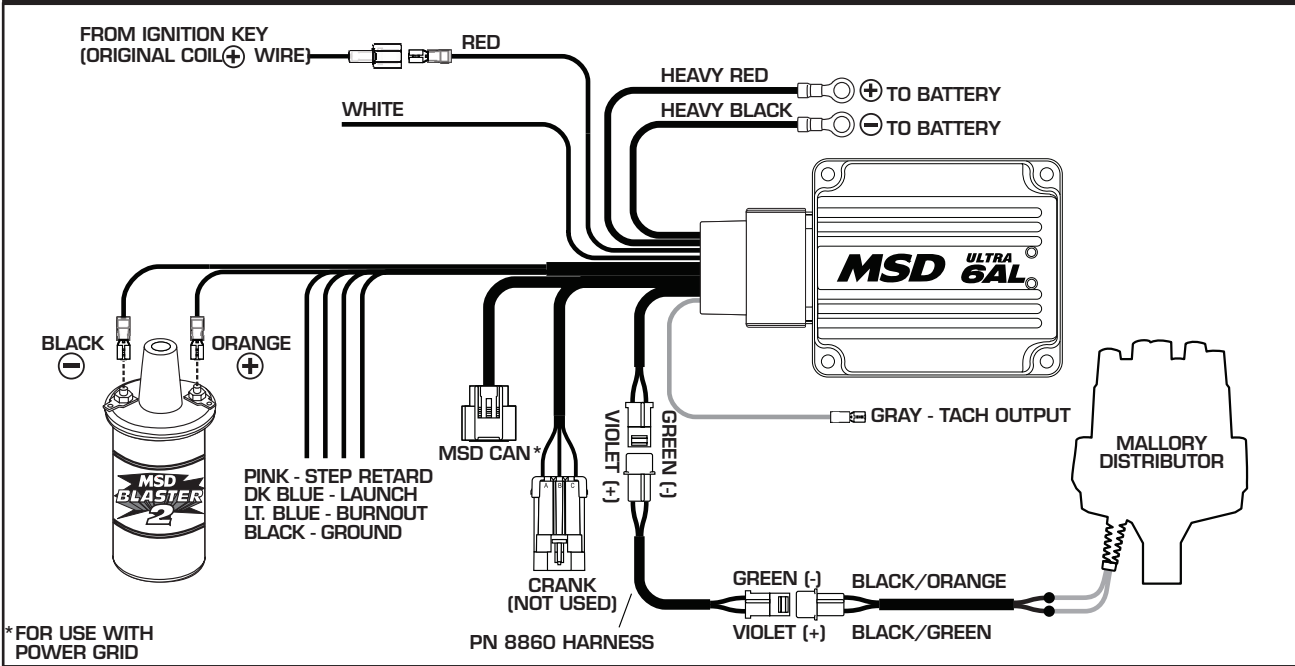

AFTERMARKET COMPONENTS Wiring to a Pertronix Ignitor Kit.

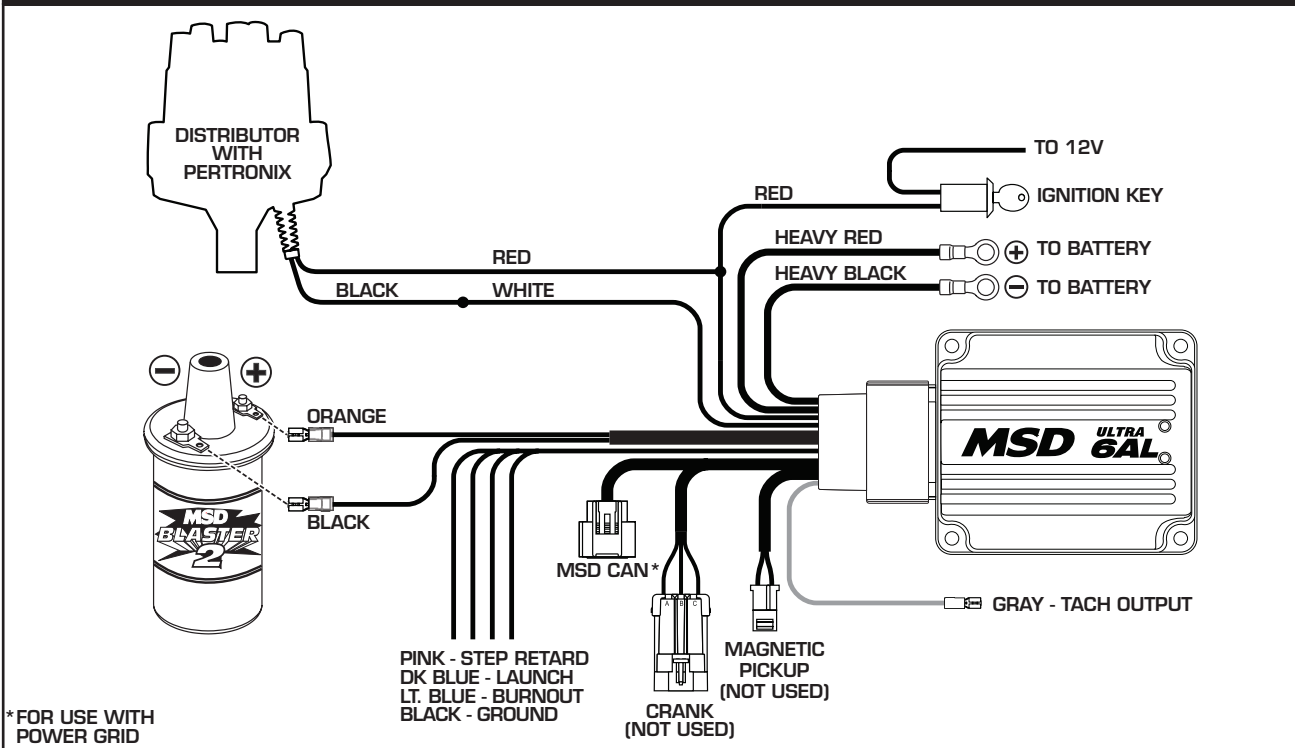

If you did not find a schematic to match your application, or if you need assistance, please contact MSD Tech at (888) 464-6553.

APPENDIX A - ULTRA IGNITION TIMING CONTROL: ROTOR PHASING DETAILS

DIST	APPLICATION	DESCRIPTION	ROTOR NEEDED	ROTOR RETARD NEEDED	NOTES
83506	FORD	R-t-R Marine Ford 351-460	84211	15°	
8517	BUICK	Buick V8 Billet, 400-455	84211	15°	
8548	BUICK	Buick V8 215-350 Pro Billet	84211	15°	
8547	CHEVY	Super Tall Block, Mag Pick.	8421	15°	
8355	CHEVY	OBS-Dist,Chevy, D/ PU, Locked*Sub w/8356	84211	15°	
8356	CHEVY	Chevy V8, Dual Pickup	84211	15°	
85501	CHEVY	Chevy V8,Pro-Bill,locked,cap,rotor	84211	15°	
85503	CHEVY	Chevy V8, w/Capadapt/ locked Shaf	84211	15°	
85551	CHEVY	Chevy V8,Pro-Billet,w/Cap, Rotor	84211	15°	
85553	CHEVY	Chevy V8, Mod Shafiroff	84211	15°	
85561	CHEVY	Chevy V8 w/Slip Collar,Cap, Rotor	84211	15°	
83606	CHEVY	R-t-R Marine Chevy V8	84211	15°	
8534	CHRY	Chrysler, 318, 360	84211	15°	
8582	FORD	Ford V8, 302	8421	15°	
8598	FORD	Ford 289/302 Hyd Roller-Steel Gear	8421	15°	
8580	FORD	Ford V8, 351C, 460	8421	15°	
85805	FORD	Ford 351W, w/ Edel. Vic. Jr	8421	15°	
8584	FORD	Ford V8, 351W	8421	15°	
85840	FORD	Ford 351W,w Roller Stl Gear	8421	15°	
8569	FORD	Ford 351C/M, 460, L.P., CT	84211	15°	
8498	GM	OBS-GM Ecotec 4 cylinder	8421	15°	
8589	HOLDEN	Holden V8 308 ci engines	84211	15°	
8566	OLDS	Oldsmobile V8, 350, 455	84211	15°	
8490	PONT	OBS-151 4Cyl	8421	15°	
8563	PONT	Pontiac V8, 350, 455	84211	15°	
2345	CHEVY	Ign. Trigger Sync Signal Lock/Out	84211	15°	
23451	CHEVY	Ign Trig. w/Hall LED Sync Pickup	84211	15°	
2357	CHEVY	Cam Sync w/Rotor Phasing, Chevy V8	84211	15°	
8570	CHEVY	Chevy V8,Small Cap/Base	84211	15°	
8545	CHRY	Chrysler 383,400 Pro-Billet	84211	15°	
8546	CHRY	Chrysler 426,440	84211	15°	
2358	FORD	Sync Rotor Phas, 289/302 Steel Ger	84211	15°	
2359	FORD	Sync Rotor Phas, 289/302, Cast Ger	84211	15°	
2360	FORD	Sync Rotor Phas, 289/302 Bronze Gr	84211	15°	
8579	FORD	Ford 302, Pro Billet, Small Cap	84211	15°	
2362	FORD	Sync Rotor Phas, 351W, Steel Gear	84211	15°	
2363	FORD	Sync Rotor Phasing, Ford FE, Roush	84211	15°	
8577	FORD	Ford 351C-460, ProBillet, Small Cap	84211	15°	
8578	FORD	Ford 351W, Pro Billet, Small Cap	84211	15°	
8394	CHEVY	GM Digital E-Curve	84211	15°	
8504	CHRY	Chry 318, 340, 360, E-Curve	84211	15°	
8503	FORD	Ford 289/302, E-Curve	84211	15°	
8477	FORD	Ford 351C-460, Vac. Advance	84211	15°	Keep Vacuum Canister in place.
8478	FORD	Ford 351W, Vacuum Advance	84211	15°	Keep Vacuum Canister in place.
8479	FORD	Ford 289/302, VacuumAdvance	84211	15°	Keep Vacuum Canister in place.
8386	CHRY	Chry. 383-400, R-t-R	84211	15°	Keep Vacuum Canister in place.
8387	CHRY	Chry. 440,426 R-t-R	84211	15°	Keep Vacuum Canister in place.
8350	FORD	Ford 351C-460, R-t-R	84211	15°	Keep Vacuum Canister in place.
83501	FORD	Ford 351C-460, R-t-R,Stl Gr	84211	15°	Keep Vacuum Canister in place.
8352	FORD	Ford 289/302, R-t-R	84211	15°	Keep Vacuum Canister in place.
83521	FORD	Ford 289/302, R-t-R, Stl Gr	84211	15°	Keep Vacuum Canister in place.
8354	FORD	Ford 351W, R-t-R	84211	15°	Keep Vacuum Canister in place.
83541	FORD	Ford 351W, R-t-R, Steel Ger	84211	15°	Keep Vacuum Canister in place.
8383	FORD	R-t-R, Ford Y Block	84211	15°	Keep Vacuum Canister in place.
8595	FORD	R-t-R, Ford FE	84211	15°	Keep Vacuum Canister in place.
8523	AMC	R-t-R, AMC V8	84211	15°	Remove Vacuum Canister and lockout advance.
8519	AMC	AMC V8 Engines	84211	15°	Remove Vacuum Canister and lockout advance.
8524	BUICK	R-t-R Buick Nailhead	84211	15°	Remove Vacuum Canister and lockout advance.
8552	BUICK	R-t-R, Buick 455 V8	84211	15°	Remove Vacuum Canister and lockout advance.
8360	CHEVY	Chevy V8 w/Internal Module	84211	15°	Remove Vacuum Canister and lockout advance.
83602	CHEVY	Chevy w/Int Module, wo/Vac Advance	84211	15°	Remove Vacuum Canister and lockout advance.

APPENDIX A - ULTRA IGNITION TIMING CONTROL: ROTOR PHASING DETAILS

DIST	APPLICATION	DESCRIPTION	ROTOR NEEDED	ROTOR RETARD	NOTE
8360EDEL	CHEVY	Chevy V8, R-t-R, Edelbrock Crate	84211	15°	Remove Vacuum Canister and lockout advance.
8393	CHEVY	Chevy 348/409 R-t-R	84211	15°	Remove Vacuum Canister and lockout advance.
8361	CHEVY	Chevy V8, Billet w/Vacuum Adv.	84211	15°	Remove Vacuum Canister and lockout advance.
8363	CHEVY	Cadillac V8 w/Vacuum Advance	84211	15°	Remove Vacuum Canister and lockout advance.
8388	CHRY	Chry. 440,426 R-t-R	84211	15°	Remove Vacuum Canister and lockout advance.
8389	CHRY	R-t-R, Chry	84211	15°	Remove Vacuum Canister and lockout advance.
8391	CHRY	R-t-R, Chrysler 331	84211	15°	Remove Vacuum Canister and lockout advance.
8573	FORD	Flathead Ford, R-t-R, 49-53	84211	15°	Remove Vacuum Canister and lockout advance.
85891	HOLDEN	Holden R-t-R V8 308	84211	15°	Remove Vacuum Canister and lockout advance.

TECH NOTES

TECH NOTES

Service

In case of malfunction, this MSD component will be repaired free of charge according to the terms of the warranty. When returning MSD components for warranty service, **Proof of Purchase** must be supplied for verification. After the warranty period has expired, repair service is based on a minimum and maximum fee.

All returns must have a Return Material Authorization (RMA) number issued to them before being returned. To obtain an RMA number please contact MSD Customer Service at 1 (888) MSD-7859 or visit our website at www.msdpower.com/rma to automatically obtain a number and shipping information.

When returning the unit for repair, leave all wires at the length in which you have them installed. Be sure to include a detailed account of any problems experienced, and what components and accessories are installed on the vehicle. The repaired unit will be returned as soon as possible using Ground shipping methods (ground shipping is covered by warranty). For more information, call MSD at (888) 464-6553. MSD technicians are available from Monday - Friday 7am - 4pm and Saturdays from 7am - 1pm MST

Limited Warranty

MSD warrants this product to be free from defects in material and workmanship under its intended normal use*, when properly installed and purchased from an authorized MSD dealer, for a period of one year from the date of the original purchase. This warranty is void for any products purchased through auction websites. If found to be defective as mentioned above, it will be repaired or replaced at the option of MSD. Any item that is covered under this warranty will be returned free of charge using Ground shipping methods.

This shall constitute the sole remedy of the purchaser and the sole liability of MSD. To the extent permitted by law, the foregoing is exclusive and in lieu of all other warranties or representation whether expressed or implied, including any implied warranty of merchantability or fitness. In no event shall MSD or its suppliers be liable for special or consequential damages.

*Intended normal use means that this item is being used as was originally intended and for the original application as sold by MSD. Any modifications to this item or if it is used on an application other than what MSD markets the product, the warranty will be void. It is the sole responsibility of the customer to determine that this item will work for the application they are intending. MSD will accept no liability for custom applications.